

LED EXPLOSION PROOF LIGHT

Explosion Proof Outdoor LED Luminaire (S SERIES)

This LED Explosion Proof Light can provide general illumination in hazardous locations such as oil refineries, gasoline loading docks, distilleries, pumping stations, mines, vessels, paint manufacturing plants and other high humidity, high temperature, dusty locations.

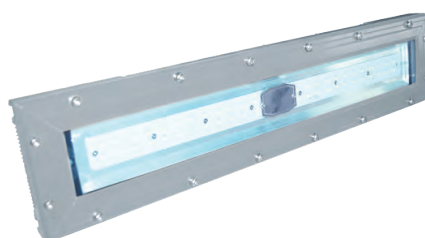

DIMENSIONS

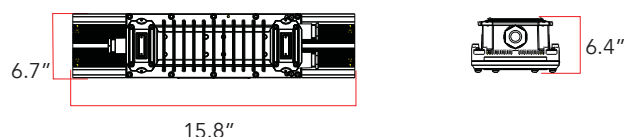

| Voltage | 2FT – DIMS (in) | 4FT – DIMS (in) |
|------------|-----------------|-----------------|
| AC100-277V | 24"x5.4"x3.5" | 47.5"x5.4"x3.5" |

FEATURES

- Surface mounting and pendant installation
- High vibration resistance
- IP66 Rating
- Wide and narrow optics for uniform illumination
- Copper free aluminum
- Limited Warranty: 5 year (10 year optional)

WARRANTY

This product has a warranty for a period of 5 year from the date of purchase. The warranty is invalid in the case of improper installation, tampering, or removal of the Q.C. date label. Installation in an improper working environment or installation not according to the current edition of the National Electric Code also invalidates the warranty. Should this product fail during the warranty period, it will be replaced free of charge, subject to correct installation and return of the faulty unit. Patriot Lighting does not accept responsibility for any installation costs associated with the replacement of this product. This warranty is in addition to the statutory rights in the country of purchase. Patriot Lighting reserves the right to alter specifications without prior notice.

CERTIFICATIONS & RATINGS



- NEMA 4X, IP66
- UL1598/UL1589A/UL844
- CSA C22.2 No. 137/No.250.0
- IECEX
- ATEX
- L70

Class I, Division 2, Groups A,B,C,D
 Class II, Division 2, Groups F,G
 Class III

COMMON TECHNICAL DATA

| | |
|-----------------------|-------------------|
| Color Temperature | 2700K to 6400K |
| CRI | > 80 |
| Beam Angle | 120° |
| Operation Temperature | -40°C to 60°C |
| Efficiency | More than 130 LPW |
| Input Voltage | AC100-277V |
| Frequency | 50-60Hz |
| Power Factor | More than 0.90 |
| Rated Life | 150,000 hours |

LED EXPLOSION PROOF LIGHT

Explosion Proof Outdoor LED Luminaire (S SERIES)

PRODUCT SPECIFICATION

| Product Number | Wattage | CCT | Voltage | Lumens | Working Hrs | CRI |
|----------------|---------|-------------|------------|--------|-------------|-----|
| PT-36W2FT | 36 | 2700K-6400K | AC100-277V | 4500 | 150,000 | 70 |
| PT-48W2FT | 48 | 2700K-6400K | AC100-277V | 6000 | 150,000 | 70 |
| PT-56W2FT | 56 | 2700K-6400K | AC100-277V | 7000 | 150,000 | 70 |
| PT-36W4FT | 36 | 2700K-6400K | AC100-277V | 4500 | 150,000 | 70 |
| PT-48W4FT | 48 | 2700K-6400K | AC100-277V | 6000 | 150,000 | 70 |
| PT-56W4FT | 56 | 2700K-6400K | AC100-277V | 7000 | 150,000 | 70 |
| PT-72W4FT | 72 | 2700K-6400K | AC100-277V | 9000 | 150,000 | 70 |
| PT-100W4FT | 100 | 2700K-6400K | AC100-277V | 12500 | 150,000 | 70 |

ORDERING GUIDE

| PT | 2FT/4FT | 36W/48W/56W/72W/100W | 2700K-6400K | 120° | PM/SM/WM/PC |
|--------------|---------|----------------------|-------------|------------|------------------|
| Company Code | Length | Wattage | CCT | Beam Angle | Mounting Options |

MOUNTING OPTIONS

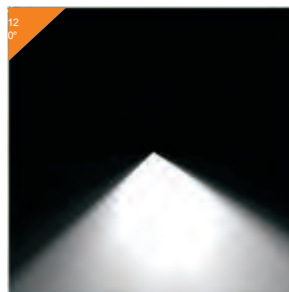
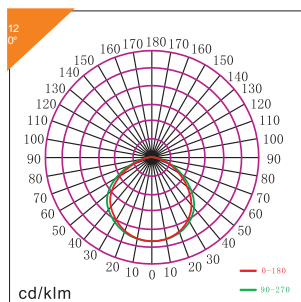

CAUTION

- Risk of fire- make sure power is OFF before installation.
- Risk of electric shock- make installation with gloves.
- All wiring needs to be performed per National Electrical Code and local code by a qualified electrician.
- High temperatures inside luminaire make certain line voltage corresponds with ballast's primary voltage.
- If the lamp or luminaire exhibits undesirable operation (i.e. buzzing, flickering, etc.), immediately turn off power and remove the lamp from luminaire and contact manufacturer.
- Luminaires should not be installed in narrow space to guarantee enough air convection.
- Do not make mass installation before sample testing.

LED EXPLOSION PROOF LIGHT

Explosion Proof Outdoor LED Luminaire (S SERIES)

STRUCTURE DIAGRAM

36W/48W/56W

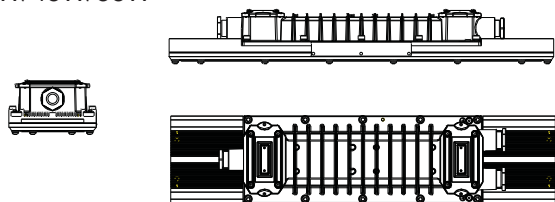

36W/48W/56W/72W/100W

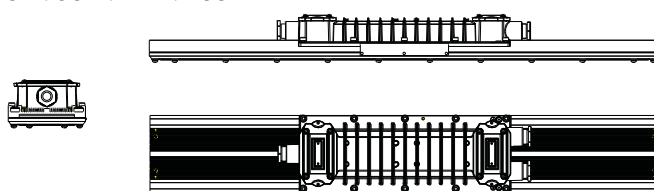

MOUNTING OPTIONS

Pipe
Clamp

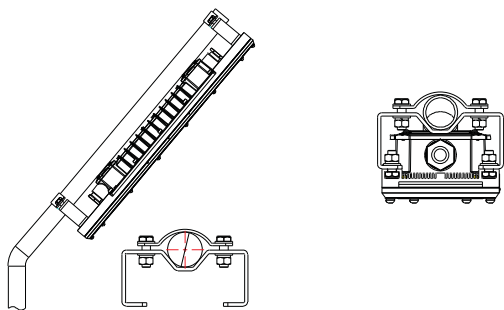

Wall
Mount

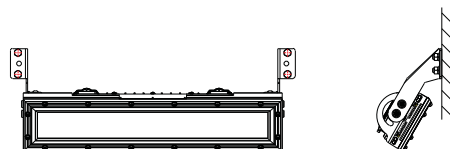

Stanchion
Mount

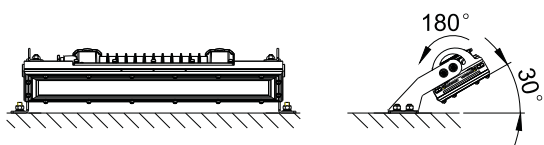

Clamp
Mount

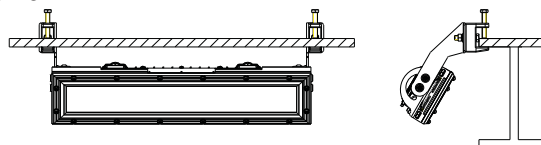

Ceiling
Mount

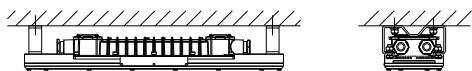

Pendant
Mount

