

DATA SHEET: PLUG & PLAY HO T8 LED Tube

The Patriot Plug and Play HO T8 LED tube ONLY achieving UL, ETL which can work with most T8 Electronic and magnetic start ballast. Proudly assembled in USA. Buy American Act (BAA) Compliant.

Our Plug and Play HO T8 LED tubes are ballast ready for easy installation and are backed with our industry-leading 100,000-hour rated lamp life and 10-year warranty. See Ordering Model table below for our BAA compliant products. Contact us for pricing or more information.

PRODUCT BENEFITS

- Pretty and elegant appearance, patented product.
- Directly install on the existing T8 fixture.
- Colorful metal rings available, Blue, Green, Silver, Red and Gold.
- G13 fixed or rotating end cap is available.
- 6063 Aluminum shell, Japan PC cover, long lifespan.
- OEM service available, Laser print customer LOGO and customer exclusive label.
- Mainly used in factory,supermarket,carpark,hospital and school.
- Rated Life: 100,000 hrs.
- Limited Warranty: 5 year (10 year optional).



BEAM ANGLE



Patriot LED Light Distribution

CAN DECREASE ENERGY USAGE BY

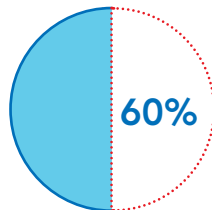

vs. Similar Fluorescent Lamps

WARRANTY



Our Industry-Leading 10-Year Limited Warranty Guarantees Unsurpassed Quality

TECHNICAL DATA

- Input Voltage: AC100 -277 V 50/60Hz
- Power: 9W - 18 W
- Color temperature: 3000K, 4000K, 5000K, 6000K
- Color Rendering Index: >80
- Power Factor: >0.95
- Working Temperature: -20~40°C
- Storage Temp: -40~80°C
- Environment Humidity: <95%

ORDERING MODEL

PATRIOT TUBE	TUBE TYPE	LENGTH	WATTAGE	CCT
PT	DGA00	2FT 4FT	9W	3000K
			10W	4000K
			15W	5000K
			18W	6000K
Product Code: example				
PT-DGA00-209WT-G8-H				





DATA SHEET: PLUG & PLAY HO T8 LED Tube

PRODUCT SPECIFICATION

Product No.	BAA/ TAA Option	Length	Clear Cover	Rated Lamp Wattage	Lumen (lm)	Input Voltage	Color	CRI	Power Factor	Beam Angle	Rated Life (Hours)	Working Temp.	Storage Temp	Env. Humidity
130 lm/w Frosted Cover - T8 PLUG & PLAY LED Tube														
PT-DGA00-209WT-G8-H	Yes	2FT	135lm/W	9W	1170	AC100-277V 50/60Hz	3500K - 4000K 5000K - 6000K	>80	>0.95	140°	100,000	-20~40°C	-40~80°C	<95%
PT-DGA00-410WT-G8-H	Yes	4FT	135lm/W	10W	1300	AC100-277V 50/60Hz	3500K - 4000K 5000K - 6000K	>80	>0.95	140°	100,000	-20~40°C	-40~80°C	<95%
PT-DGA00-415WT-G8-H	Yes	4FT	135lm/W	15W	1950	AC100-277V 50/60Hz	3500K - 4000K 5000K - 6000K	>80	>0.95	140°	100,000	-20~40°C	-40~80°C	<95%
PT-DGA00-418WT-G8-H	Yes	4FT	135lm/W	18W	2340	AC100-277V 50/60Hz	3500K - 4000K 5000K - 6000K	>80	>0.95	140°	100,000	-20~40°C	-40~80°C	<95%
PT-DGA00-209WT-D8-H	Yes	2FT	135lm/W	9W	1170	AC100-277V 50/60Hz	3500K - 4000K 5000K - 6000K	>80	>0.95	140°	100,000	-20~40°C	-40~80°C	<95%
PT-DGA00-410WT-D8-H	Yes	4FT	135lm/W	10W	1300	AC100-277V 50/60Hz	3500K - 4000K 5000K - 6000K	>80	>0.95	140°	100,000	-20~40°C	-40~80°C	<95%
PT-DGA00-415WT-D8-H	Yes	4FT	135lm/W	15W	1950	AC100-277V 50/60Hz	3500K - 4000K 5000K - 6000K	>80	>0.95	140°	100,000	-20~40°C	-40~80°C	<95%
PT-DGA00-418WT-D8-H	Yes	4FT	135lm/W	18W	2340	AC100-277V 50/60Hz	3500K - 4000K 5000K - 6000K	>80	>0.95	140°	100,000	-20~40°C	-40~80°C	<95%
160 lm/w Frosted Cover - T8 PLUG & PLAY LED Tube														
PT-DGA00-209WT-G8-H	Yes	2FT	165lm/W	9W	1440	AC100-277V 50/60Hz	3500K - 4000K 5000K - 6000K	>80	>0.95	140°	100,000	-20~40°C	-40~80°C	<95%
PT-DGA00-410WT-G8-H	Yes	4FT	165lm/W	10W	1600	AC100-277V 50/60Hz	3500K - 4000K 5000K - 6000K	>80	>0.95	140°	100,000	-20~40°C	-40~80°C	<95%
PT-DGA00-415WT-G8-H	Yes	4FT	165lm/W	15W	2400	AC100-277V 50/60Hz	3500K - 4000K 5000K - 6000K	>80	>0.95	140°	100,000	-20~40°C	-40~80°C	<95%
PT-DGA00-418WT-G8-H	Yes	4FT	165lm/W	18W	2880	AC100-277V 50/60Hz	3500K - 4000K 5000K - 6000K	>80	>0.95	140°	100,000	-20~40°C	-40~80°C	<95%
PT-DGA00-209WT-D8-H	Yes	2FT	165lm/W	9W	1440	AC100-277V 50/60Hz	3500K - 4000K 5000K - 6000K	>80	>0.95	140°	100,000	-20~40°C	-40~80°C	<95%
PT-DGA00-410WT-D8-H	Yes	4FT	165lm/W	10W	1600	AC100-277V 50/60Hz	3500K - 4000K 5000K - 6000K	>80	>0.95	140°	100,000	-20~40°C	-40~80°C	<95%
PT-DGA00-415WT-D8-H	Yes	4FT	165lm/W	15W	2400	AC100-277V 50/60Hz	3500K - 4000K 5000K - 6000K	>80	>0.95	140°	100,000	-20~40°C	-40~80°C	<95%
PT-DGA00-418WT-D8-H	Yes	4FT	165lm/W	18W	2880	AC100-277V 50/60Hz	3500K - 4000K 5000K - 6000K	>80	>0.95	140°	100,000	-20~40°C	-40~80°C	<95%
175 lm/w Frosted Cover - T8 PLUG & PLAY LED Tube														
PT-DGA00-209WT-G8-H	Yes	2FT	180lm/W	9W	1575	AC100-277V 50/60Hz	3500K - 4000K 5000K - 6000K	>80	>0.95	140°	100,000	-20~40°C	-40~80°C	<95%
PT-DGA00-410WT-G8-H	Yes	4FT	180lm/W	10W	1750	AC100-277V 50/60Hz	3500K - 4000K 5000K - 6000K	>80	>0.95	140°	100,000	-20~40°C	-40~80°C	<95%
PT-DGA00-415WT-G8-H	Yes	4FT	180lm/W	15W	2625	AC100-277V 50/60Hz	3500K - 4000K 5000K - 6000K	>80	>0.95	140°	100,000	-20~40°C	-40~80°C	<95%
PT-DGA00-418WT-G8-H	Yes	4FT	180lm/W	18W	3150	AC100-277V 50/60Hz	3500K - 4000K 5000K - 6000K	>80	>0.95	140°	100,000	-20~40°C	-40~80°C	<95%
PT-DGA00-209WT-D8-H	Yes	2FT	180lm/W	9W	1575	AC100-277V 50/60Hz	3500K - 4000K 5000K - 6000K	>80	>0.95	140°	100,000	-20~40°C	-40~80°C	<95%
PT-DGA00-410WT-D8-H	Yes	4FT	180lm/W	10W	1750	AC100-277V 50/60Hz	3500K - 4000K 5000K - 6000K	>80	>0.95	140°	100,000	-20~40°C	-40~80°C	<95%
PT-DGA00-415WT-D8-H	Yes	4FT	180lm/W	15W	2625	AC100-277V 50/60Hz	3500K - 4000K 5000K - 6000K	>80	>0.95	140°	100,000	-20~40°C	-40~80°C	<95%
PT-DGA00-418WT-D8-H	Yes	4FT	180lm/W	18W	3150	AC100-277V 50/60Hz	3500K - 4000K 5000K - 6000K	>80	>0.95	140°	100,000	-20~40°C	-40~80°C	<95%

PHYSICAL DATA

Product No.	Length	Size(mm)	Carton Size(cm)	GW/25PCS	Certification
PATRIOT T8 HO PLUG AND PLAY LED Tube					
PT-DGA00-209WT-G8-H	2FT	φ26*L548	L66*W22*H22	7.6kg	UL,cUL,DLC V4.2 and Lighting Facts
PT-DGA00-410WT-G8-H	4FT	φ26*L1198	L126*W22*H22	11.8kg	UL,cUL,DLC V4.2 and Lighting Facts
PT-DGA00-415WT-G8-H	4FT	φ26*L1198	L126*W22*H22	11.8kg	UL,cUL,DLC V4.2 and Lighting Facts
PT-DGA00-418WT-G8-H	4FT	φ26*L1198	L126*W22*H22	11.8kg	UL,cUL,DLC V4.2 and Lighting Facts
PT-DGA00-209WT-D8-H	2FT	φ26*L548	L66*W22*H22	7.6kg	UL,cUL,DLC V4.2 and Lighting Facts
PT-DGA00-410WT-D8-H	4FT	φ26*L1198	L126*W22*H22	11.8kg	UL,cUL,DLC V4.2 and Lighting Facts
PT-DGA00-415WT-D8-H	4FT	φ26*L1198	L126*W22*H22	11.8kg	UL,cUL,DLC V4.2 and Lighting Facts
PT-DGA00-418WT-D8-H	4FT	φ26*L1198	L126*W22*H22	11.8kg	UL,cUL,DLC V4.2 and Lighting Facts

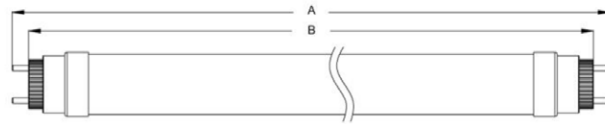

DRAWING OF PRODUCTS

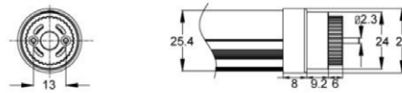

	2feet	3feet	4feet	5feet
	588mm	894mm	1198mm	1498mm
A	602mm	908mm	1212mm	1512mm
B	588mm	894mm	1198mm	1498mm

PACKAGE



INSTALLATION

Solution1

Step 1: Turn off the power to the light fixture at the main service panel.

Step 2: Remove the diffuser (if any) and fluorescent tube.

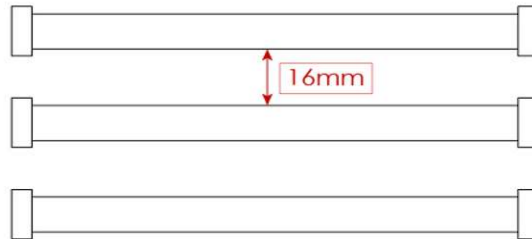

Step 3: Check the wires of the light fixture before installation of the LED retrofit kit.

a. If the light fixture is providing with magnetic ballast and starter, disconnect and rewiring the wires at the point as shown in the following figures (see Figure 1 to Figure 2).

Figure 1: Before retrofit.

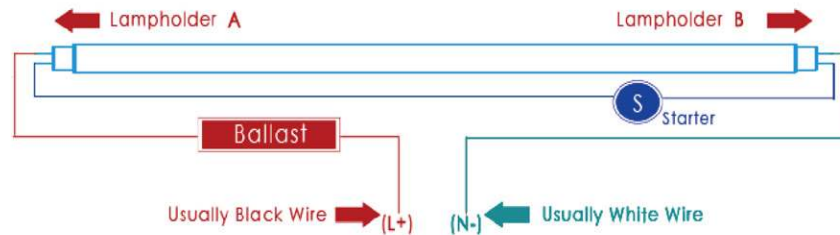
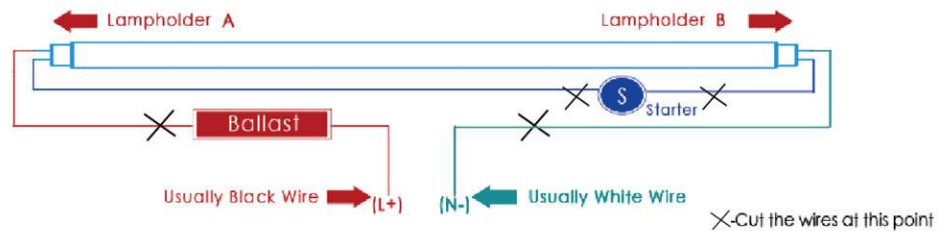
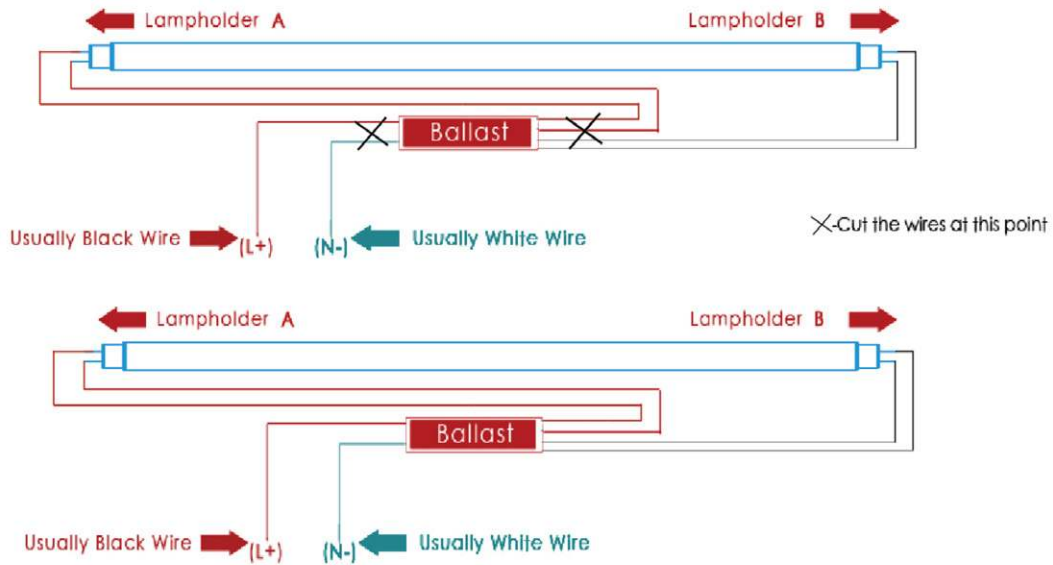

Figure 2: Under retrofit - Cut the wires connected to the ballast and starter, and Lampholders as shown.



b. If the light fixture is providing with electronic ballast, disconnect and rewiring the wires at the point as shown in the following figures (see Figure 3 to Figure 4).

Figure 3: Before retrofit.



Step 5: Both line and neutral power are required to be connected to the same Lampholder as shown in Figure 6.

Figure 6: After retrofit – Rewiring the wires from Lampholder A to “L” and “N” of the supply circuit by wire nuts/connectors. Insulated or capped all unused conductors with a wire connectors.



Solution2

